

---

# MODEL: WITNESS SEMI-AUTOMATIC PISTOL



## WARNINGS AND INSTRUCTION MANUAL

### MANUAL FOR

#### WITNESS AND WITNESS P SEMIAUTOMATIC FIREARMS

9 mm - FULL SIZE - 10RDS  
9 mm - COMPACT - 10RDS  
.38 SUPER - FULL SIZE - 10RDS  
.38 SUPER - COMPACT - 10RDS  
40SW - FULL SIZE - 10RDS

40SW - COMPACT - 9RDS  
.45ACP - FULL SIZE - 10RDS  
.45ACP - COMPACT - 8RDS  
10mm - FULL SIZE - 10RDS  
10mm - COMPACT - 9RDS

FINISHES AVAILABLE:  
B - BLUE  
C - CHROME  
W - WONDER  
BW - BLUE WONDER

**Important!**  
**Read these Warnings and  
Instructions before using firearm!**

Note:

**WARNING!**

If you have a Wonder finish  
Model you must oil and  
maintain it as if it were  
Blue Steel.

DO NOT USE +P Ammo or  
High Velocity High Pressure  
Ammunition  
(factory or hand-loaded)

# MODEL: WITNESS SEMI-AUTOMATIC PISTOL

## WARNINGS AND INSTRUCTION MANUAL PLEASE READ THESE INSTRUCTIONS

**FOR YOUR SAFETY AND THE SAFETY OF OTHERS**, this owner's manual contains important warnings, instructions and safety procedures which must be understood BEFORE using this firearm. Read the **ENTIRE MANUAL** and if you do not understand any part of it or the operation of your pistol, stop and seek professional firearms instruction. You can get a copy of this manual from European American Armory Corp. upon request.

Record the serial number of your firearm (located on the receiver on the right hand side):

# \_\_\_\_\_

and a description of it:

\_\_\_\_\_

Make a copy of this manual, proof of purchase/sales record for safekeeping in a secure safe or fireproof container. Such proof is necessary if the firearm is damaged, stolen or sent in for warranty repair.

## **WARNING**

### **\*YOU RISK PERSONAL INJURY OR DEATH BY HANDLING THIS FIREARM\***

Before handling any firearm, make sure you know the safety procedures and most importantly, keep the firearm pointed in a safe direction.

Before handling this firearm, read, understand and follow the instructions in this manual. Always keep this manual with the firearm. If you lend, give or sell this firearm, be sure the manual goes with it. If there is anything you do not understand, seek advice from someone qualified in safe handling of firearms. You must ALWAYS obey the following warnings, instructions and safety procedures:

1. Always keep the muzzle pointed in a safe direction.
2. Firearms should be unloaded and secured when not actually in use.
3. Don't rely on your firearm's safety.
4. Be sure of your target and what's beyond it.
5. Use only proper ammunition matching the precise caliber of your specific pistol.
6. If your pistol fails to fire when the trigger is pulled, handle with care.
7. Always wear ear and eye protection when shooting.
8. Be sure the barrel is clear of obstructions before shooting.
9. Don't alter or modify your firearm and have it serviced regularly.
10. Learn the mechanical and handling characteristics of your pistol.
11. Shoot sober!

## **Type Of Ammunition To Be Used**

It is suggested that high quality commercially manufactured ammunition be used in this firearm. Avoid military surplus or old ammunition as it may not fire with sufficient force to expel the projectile from the barrel. **The use of reloaded, high pressure or hand-loaded ammunition can be dangerous and will void the warranty.**

**LEAD WARNING:** The actual firearm does not contain any lead; however, it does fire ammunition which contains lead or lead compounds known to the State of California to cause cancer, birth defects, reproductive toxicity, and other serious physical injury. Those who discharge a firearm, stand near someone who discharges a firearm or clean firearms are hereby warned of the dangers presented by lead and lead compounds and should take protective health measures. Avoid exposure to lead while handling and wash your hands after contact. Proper air ventilation is absolutely necessary when shooting indoors.

## **NOTICE**

**SEMI-AUTOMATIC PISTOLS ARE CLASSIFIED AS FIREARMS OR DANGEROUS WEAPONS** and are sold by European American Armory Corp. with the specific understanding that we are not responsible in any manner whatsoever for their safe handling or resale under local laws and regulations.

European American Armory Corp. shall not be responsible in any manner whatsoever for malfunctioning of the firearm, for physical injury or for property damage resulting in whole or in part from **(1)** intentional or negligent discharge, **(2)** improper or careless handling, **(3)** unauthorized modifications and/or alteration of the internal/safety mechanisms, **(4)** defective, improper, high pressure, hand-loaded, or reloaded ammunition, **(5)** corrosion and/or lack of proper maintenance **(6)** neglect, or **(7)** other influences beyond our direct and immediate control. This limitation applies regardless of whether liability is asserted on the basis of contract, negligence or strict liability (including any failure to warn). Under no circumstance shall European American Armory Corp. be liable for incidental or consequential damages, such as loss of use of property, commercial loss and loss of earnings or profits.

## **FOLLOWING THESE SAFETY RULES CAN SAVE YOUR LIFE OR THE LIFE OF SOMEONE ELSE**

Get competent firearms instruction in safe handling before using this firearm. Please ask your dealer for names of qualified instructors near you. All guns are extremely dangerous if carelessly handled or used. Remember that the firearm user is the primary “safety” and that reliance on any mechanical safety device should never replace safe handling procedures.

This firearm **WILL FIRE** if a cartridge is in the chamber and the trigger is pulled while the safety is disengaged.

**DO NOT LOAD THIS PISTOL UNTIL YOU UNDERSTAND HOW IT OPERATES.** **KEEP** this pistol unloaded at all times except when you are ready to fire and are sure of your target.

**ALWAYS** carry this pistol in a case or original box unloaded.

**NEVER** point this pistol at anything that is not your intended target even if the pistol is unloaded. When loading, unloading, cleaning or handling, always be sure the muzzle is pointed in a safe direction and always keep your finger off the trigger.

**NEVER** assume any gun is unloaded. Before handling, check to make sure the chamber is empty. See Unloading Instructions. Make sure you know that this or any firearm is fully unloaded before displaying or handling it. When handling any firearm, keep your fingers away from the trigger at all times until you intend to fire.

Get instructions from a competent firearms instructor before using this or any firearm. Learn from a professional how to handle, load, unload, operate, fire and care for your gun.

**NEVER PLAY** with your firearm. It is not a toy and can be a very dangerous weapon that can cause serious personal injury or death.

Always keep the gun pointed in a safe direction. Treat every gun as if it is loaded...all the time. **NEVER** point any firearm (loaded or unloaded) at any person or anything you do not intend to shoot. Always keep your gun unloaded until ready to use and make sure that it is unloaded before cleaning.

Keep your finger **OFF** the trigger until you are actually aiming at the target and ready to shoot. Learn to rest your finger outside of the trigger guard.

Never rely on a gun’s “safety” to protect you from unsafe gun handling. A safety is

## **FOLLOWING THESE SAFETY RULES CAN SAVE YOUR LIFE OR THE LIFE OF SOMEONE ELSE**

only a mechanical device, not a substitute for using common sense and following gun safety procedures.

Never leave a gun unattended or where it could fall.

Store guns and ammunition separately **beyond the reach of children**. Make sure that they are properly secured so untrained individuals and children will be denied access to your guns and ammunition.

Test your gun's operation and safeties only at a shooting range while the firearm is pointed in a safe direction.

Know your target and what is beyond. Ask yourself what your projectile will hit if it misses the target or passes through the intended target. Remember, a fired projectile can travel over a mile (including a ricochet) and is capable of going through walls. Never shoot at hard flat surfaces or water . . . bullets ricochet.

Guns and alcohol or drugs do not mix. Don't take any alcoholic beverages and/or drugs before or during shooting activities.

Never pull a gun toward you by the muzzle. Don't climb a tree, cross a ditch or fence with a loaded gun.

Always empty guns before entering a house, car, truck, boat, RV, camp or any building.

When receiving a gun, always open the action and check to make sure the chamber is unloaded.

**NEVER** accept anyone's word that a gun is "unloaded" or "empty." You should immediately open the action and check to make sure it is unloaded.

Be careful with **ALL** ammunition. Even "blank" cartridges are deadly at close range due to the muzzle blast. Make sure your ammunition is new and in good clean condition. Do **NOT** oil or grease ammunition as this may damage the cartridge primer. Do **NOT** tamper with or alter the standard factory ammunition.

Keep firearms unloaded when not actually in use. Load the gun only when on the range preparing to fire and unload it before leaving the range.

Never put your hand over the muzzle of a gun.

**ALWAYS WEAR** protective shooting glasses and hearing protection when using firearms.

## FOLLOWING THESE SAFETY RULES CAN SAVE YOUR LIFE OR THE LIFE OF SOMEONE ELSE

Spectators should be at least 10 feet behind and away from the shooter while the shooter is loading, shooting and unloading. Spectators should wear eye and ear protection and avoid distracting those shooting their firearms.

Never drop your gun. If you do drop it, unload it and check it for proper function before using it again.

Do **NOT** alter or modify your gun. Don't try to change your gun's trigger pull, because it may affect sear engagement and thereby cause accidental firing.

Do **NOT** remove any internal safety or safety device on the firearm. Safety mechanisms are designed to help protect you from personal injury or death.

Properly maintain and keep your gun clean. Keep it in a dry place away from other metals and water. If your gun shows sign of corrosion or improper operation, have it serviced by a competent gunsmith.

Keep the muzzle pointed in a safe direction when loading and unloading your gun. Never point the muzzle at anyone.

If a gun fails to fire when the trigger is pulled, keep it pointed down range at the target for 60 seconds. Sometimes slow primer ignition will cause a "hang fire" and the cartridge will go off after a short pause. If it still fails to fire, keep the muzzle pointed in a safe direction and avoid exposure to the breech, as you attempt to unload your firearm.

Never let water, snow, mud or other material enter the barrel. Always be sure the barrel is free of any obstruction.

Use the correct ammunition for your firearm. (See Ammunition Warning)

**Teach children:** **1. NOT** to touch guns, bullets, cartridges, shells, flares or any explosive device and **2.** That if they discover such a dangerous item or weapon, they must immediately report its location to their parents, school teacher or police.

Remember a firearm has the capability of taking your life or the life of someone else. Be careful with your firearm - an accident is almost always the result of not following basic safety rules.

## **Use the Security Lock Provided with your Pistol**

This pistol comes with a security lock to assist in protecting against unauthorized use. The pistol must be unloaded when the security lock and block are in place on the pistol or if the pistol is locked in its carry case. See **Figure 1**.



**Figure 1**

**WARNING:** Using the security lock and block or lockable case cannot substitute for securing your firearm and ammunition in separate, locked locations.

The security lock operates as follows:

- A) Remove security lock and block from its package that came with the firearm.
- B) Install security lock on plastic box with gun inside and magazine removed See **Figure 2**.



**Figure 2**

OR

- C) Install block on trigger and then install security lock on the security block, See **Figures 3(a, b, c)**.



**Figure 3a**



**Figure 3b**



**Figure 3c**

## **⚠ WARNING**

Always store the key to the security lock: (1) in a separate location away from the pistol; (2) in a secure location unknown and not accessible to others, especially children. Whether you secure your firearms by using the supplied security lock, a gun lock or safe or some other mechanism, it is **YOUR RESPONSIBILITY** to store your firearms in such a manner that children and other unauthorized persons cannot gain access to them.

**USED FIREARMS** - Firearms are sometimes altered to work incorrectly, or parts may be removed, lost or replaced with incorrect parts. If you got your European American Armory Corp. firearm as a used gun, **BEFORE USING IT** you should take it to a good gunsmith who knows European American Armory Corp. firearms, and have him examine it.

**WRITE EUROPEAN AMERICAN ARMORY CORP.** concerning any items or circumstances that you do not understand and which might relate to your safety



and the operation of your firearm at: European American Armory Corp., 1426 King Street, Cocoa, FL 32922. Phone: (321) 639-4842.

### **W A R N I N G (POTENTIAL OBSTRUCTIONS)**

**BEFORE LOADING** or firing a pistol, examine the bore and the firing chamber to be certain they are clean and free of any obstruction. Even a heavy coat of oil, grease, snow or water may result in damage to the firearm and injury to the shooter and/or persons near the firearm. A misfire or unusual sound upon firing is a signal to cease firing and to examine the chamber and bore. If there is any obstruction, clear the obstruction and clean the bore and chamber before firing. Any bore obstruction, even if it is only partly blocked, may cause the gun to blow up if it is fired, or may cause damage to the gun such as a bulged barrel. To avoid injury or death to the shooter or bystanders, check the barrels before shooting or if a shot does not sound normal.

### **W A R N I N G**

Always keep the muzzle pointed in a safe direction! Never attempt to load or unload any firearm inside a vehicle, building or other confined space (except a properly constructed shooting range). Enclosed areas frequently offer no completely safe direction in which to point the firearm. If an accidental discharge occurs, there is great risk of death, personal injury or property damage. Before loading, always clean all, grease and oil from the bores and chambers, and check to be certain that no obstructions are in the barrel. Any foreign matter in the barrels could result in a bulged or burst barrel or other damage to the firearm and could cause serious injury to the shooter or to others.

### **W A R N I N G**

If there is any reason to suspect that a projectile is obstructing the barrel, immediately unload the firearm (See Unloading Instructions) and check the chamber and the bore. A projectile or some other matter may be lodged some distance down the barrel where it can not easily be seen. Check the bore by using a cleaning rod to pass through the barrel. If a blockage is in the bore, **DO NOT ATTEMPT TO SHOOT IT OUT WITH ANOTHER CARTRIDGE, OR BLOW IT OUT WITH A BLANK CARTRIDGE OR A CARTRIDGE FROM WHICH THE BULLET HAS BEEN REMOVED. SUCH TECHNIQUE(S) CAN GENERATE EXCESSIVE PRESSURE, DAMAGE THE FIREARM AND CAUSE SERIOUS PERSONAL INJURY.** If the blockage can be removed with a cleaning rod, clean any unburned powder grains from the bore, chambers and mechanism before resuming shooting. If the blockage can not be dislodged by tapping it with a cleaning rod, take the firearm to a gunsmith.

### **W A R N I N G (EYE AND EAR PROTECTION)**

When shooting, full eye and ear protection is mandatory at all times. Shooters and spectators must wear shooting glasses and hearing protection to prevent eye injury and hearing loss. Vision and hearing impairment can occur with only

one moment of non-protection.

## **⚠ W A R N I N G (Mechanical Malfunctions)**

**STOP SHOOTING IMMEDIATELY AND UNLOAD YOUR FIREARM** if your firearm develops: a mechanical malfunction; binding or stoppage; spitting powder/gas; a punctured cartridge primer; a bulged or ruptured cartridge case; or a sound on firing does not sound quite right. Do **NOT** try one more shot but unload your firearm and take it and the ammunition to a qualified gunsmith or send the firearm back to European American Armory Corp. for examination. Do not assume that the pistol is empty merely because you checked the chamber. You must also check the bore for any obstruction inside the barrel.

## **BASIC PARTS OF YOUR PISTOL**

### **EXTERNAL CONTROL PARTS:**

**Trigger Block Safety:** The safety mechanism of the pistol provides protection against accidental and unintentional discharge under normal usage when properly engaged and in good working order. The safety mechanism is not a substitute for following safe gun handling rules. Do not disengage the safety unless you are ready to fire the pistol. ***MAKE SURE YOU UNDERSTAND HOW THE SAFETY WORKS BEFORE YOU LOAD OR USE THE PISTOL.***

The safety mechanism is a lever located on the side of the pistol's receiver. See **Figure 4**. The safety may be operated with the hammer cocked (fully back) or not cocked (all the way down) or in the resting position (about half way between fully cocked and not cocked) and with the pistol loaded or unloaded. To place the safety in the "on" or "safe" position, push the lever up so that it covers the red dot. When in the "on" or "safe" position, the safety blocks the rearward motion of the trigger so that it cannot be pulled to the rear thus stopping the movement of the hammer. To place the safety in the "off" or "fire" position, push the safety lever down. When in the "off" or "fire" position, the red dot is exposed. You have now disengaged the safety and the pistol is in the ready-to-fire position. See **Figure 5**. It is always a good idea to make sure the gun is pointed in a safe direction during any safety movement. See **Figure 6**.



**Figure 4**



**Figure 5**



**Figure 6**

**⚠ WARNING !**

Do not touch the trigger while moving the safety. When operating the safety, make sure you move it to the full extent of its travel in the desired direction, either fully “on” or fully “off.” Half-safe or partially-safe is **UNSAFE**.

**⚠ WARNING !**

The pistol does not incorporate a magazine disconnect safety, so the pistol may be fired with the magazine removed from the pistol.

**⚠ WARNING !**

The pistol is designed to and **WILL FIRE** when the trigger is pulled and the safety mechanism is in the “off” or “fire” position.

**Your Safety Does:** Lock the sear so the trigger cannot be moved rearward. By blocking the trigger movement the hammer is also blocked from movement. If the hammer is back and the safety is on, you can move the slide to safely check the chamber.

**Firing Pin Block:** The pistol also incorporates an automatic, internal firing pin block which stops the firing pin from traveling forward. The firing pin block is released only by pulling the trigger all the way to the rear as is done in firing the pistol. It is located at the rear of the under-right hand side of the slide, just in front of the firing pin. See **Figure 7**.

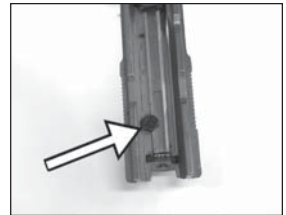

**Figure 7**

**⚠ WARNING !**

Always keep your fingers off the trigger and outside of the trigger guard until you are ready to pull the trigger and fire the pistol.

**⚠ WARNING !**

The pistol is designed to and **WILL FIRE** when the trigger is pulled and the safety mechanism is in the “off” or “fire” position.



**Figure 8**

**⚠ WARNING !**

Always keep the muzzle pointed in a safe direction! See **Figure 8**.

**Hammer:** Located on the rear of the pistol and used to supply energy to the firing pin to ignite the cartridge primer. See **Figure 9**.



**Figure 9**

## Lowering The Hammer:

### **⚠ WARNING!**

Make sure the pistol is unloaded (see Unloading Instructions) and pointed in a safe direction!

### **⚠ WARNING!**

Extreme caution must be used when lowering the hammer as the manual safety and automatic firing pin block are “off” safety when this is being done! If done incorrectly the pistol may FIRE.

### **⚠ WARNING!**

Your pistol has a resting position or notch on the hammer. This notch is not to be used as a half cock position. This notch's sole purpose is an additional notch on the hammer so as to allow the sear a chance to engage the hammer if the trigger is not pulled fully to the rear.

In order to lower the hammer, first move the safety to the “off” safe position. Grasp the hammer very firmly and put a finger between the hammer and the firing pin. See **Figure 10**. Then pull the trigger and slowly let the hammer move forward past the resting position. See **Figure 11**. **RELEASE THE TRIGGER.** Gently let the hammer down against the rear of the slide. See **Figure 12**. **PUSH THE MANUAL SAFETY LEVER TO THE “ON” OR “SAFE” POSITION.**

**Slide Stop:** Locks the slide back when engaged. It is located on left hand side of the gun. See **Figure 13**.

**Magazine Release:** Locks or holds the magazine in place and is depressed to release the magazine. See **Figure 14**.

**Rear Sight:** Drift adjustable, unless the gun is shipped with the optional windage / elevation adjustable sight. See **Figure 15**.

**Trigger:** A curved trigger is a single action / double action trigger and fires the gun in single action or double action mode. A single action only pistol has a trigger that is straight in shape and only fires the pistol in



**Figure 10**



**Figure 11**



**Figure 12**

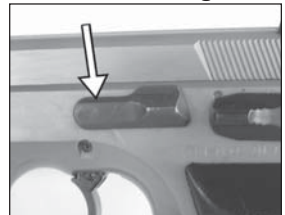

**Figure 13**

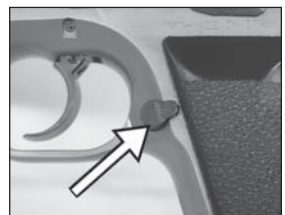

**Figure 14**



**Figure 15**

single action. See **Figure 16**. (Single action Trigger)  
See **Figure 17**. (Single Action / Double Action Trigger)

## **LOADING AND UNLOADING YOUR PISTOL**



**Figure 16**



**Figure 17**



**Figure 18**



**Figure 19**



**Figure 20**

### **⚠ WARNING !**

Make sure the pistol is pointed in a safe direction and the trigger block safety is engaged at all times while loading and unloading. **NEVER** allow your fingers or other objects to contact the trigger while loading or unloading.

### **⚠ WARNING !**

Do not disengage the trigger block safety until you are ready to fire and have the gun pointed safely downrange.

### **⚠ WARNING !**

**Do not load pistol until you are ready to fire.**

### **TO LOAD THE MAGAZINE:**

- 1) Press the magazine release button and remove the magazine from the pistol. See **Figure 18**.
- 2) Load the cartridges into the magazine. Do NOT force the cartridges into the magazine. Do NOT overload the magazine. See **Figure 19**.
- 3) Push the magazine up into the pistol firmly until the magazine catch locks it into place. Do NOT slam the magazine into place. See **Figure 20**.

### **TO LOAD THE CHAMBER:**

**MAKE SURE YOUR FINGERS ARE OFF THE TRIGGER AND AWAY FROM THE TRIGGER GUARD.**

- 1) With the gun pointed in a safe direction. Move the safety to the “off” position if the hammer is in the down position or resting position. If the hammer is in the fully cocked position you may bypass this step.
- 2) Hold the pistol grip with one hand, grasp the rear slide serrations as far back

as possible with your other hand. Pull the slide rearward until it cannot travel any farther. See **Figure 21**.

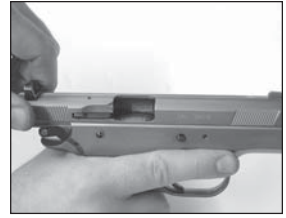

**Figure 21**

3) Release the slide and allow it to go forward into the closed position (as powdered by the recoil spring...Do not help / push the slide forward). The slide will automatically take a cartridge from the magazine and load it into the chamber. See **Figure 22**.



**Figure 22**

4) Do **NOT** put your fingers or hand in front of the barrel.

5) Move the safety to the “on” or “safe” position **IMMEDIATELY!!!!**

**WARNING! YOUR PISTOL IS NOW LOADED AND READY TO FIRE, IF THE SAFETY IS MOVED TO THE OFF OR “FIRE” POSITION AND THE TRIGGER IS PULLED THE GUN WILL FIRE.**

#### **TO UNLOAD:**

**Make Sure the Safety is in the “ON” position and the gun is pointed in a safe direction. See Figure 23.**



**Figure 23**

1) Press the magazine release button and remove the magazine from the pistol. See **Figure 24**.



**Figure 24**

#### **⚠ WARNING !**

The pistol does not incorporate a magazine disconnect safety, so the pistol may be fired with the magazine removed from the pistol.

#### **⚠ WARNING !**

Removing the magazine does not unload the chamber. If a cartridge is in the chamber the pistol can fire with the magazine removed.

2) To unload the chamber, keep your finger **OUT** of the trigger guard and **OFF THE TRIGGER** and move the safety to the off position.... **THE PISTOL CAN NOW FIRE IF YOU PULL THE TRIGGER, SO BE VERY CAREFUL!** Make sure your fingers are not in the trigger guard. Hold the pistol grip with one hand, grasp the rear slide serrations as far back as possible with your other hand. Pull the

slide rearward and eject the cartridge in the chamber. See **Figure 25**.



**Figure 25**

3) Engage the slide stop, so that the slide stays in the rearward position. See **Figure 26**.



**Figure 26**

4) Visually check the chamber to insure that there is no cartridge in the chamber. See **Figure 27**.



**Figure 27**

5) To unload the magazine you press the top cartridge in the magazine down forward and out, repeat this procedure until the magazine is completely unloaded. See **Figure 28**.



**Figure 28**

## **FIRING YOUR PISTOL**

### **⚠ WARNING**

**Never load a cartridge into the chamber until you are ready to fire the pistol.**

### **⚠ WARNING**

**Do not disengage the trigger block safety until the pistol is pointed in a safe direction and you are ready to fire.**

### **⚠ WARNING**

**If a cartridge does not fire and the trigger has been pulled and the trigger block safety is disengaged, Stop! Then do the following: a) Make sure the gun is pointed in a safe direction b) Engage the trigger block safety c) Wait 60 seconds d) Follow the instructions above for unloading the pistol.**

### **⚠ WARNING**

**If during firing the sound of any cartridge is noticeably softer or louder than the previous cartridge fired, Stop! Then do the following: a) Make sure the gun is pointed in a safe direction b) Engage the trigger block safety c) Follow the instructions above for unloading the pistol and d) With the pistol unloaded visually inspect the pistol for barrel blockage or damage. Then inspect the receiver of the pistol for damage before continuing.**

**READ, UNDERSTAND AND FOLLOW ALL WARNINGS AND INSTRUCTIONS IN THIS MANUAL BEFORE FIRING THE PISTOL.**

## TO FIRE THE PISTOL:

- 1) Make sure the pistol is pointed in a safe direction with the trigger block safety engaged. See **Figure 29**.
- 2) Make sure you are wearing eye and ear protection.
- 3) Keep your fingers away from the trigger. See **Figure 30**.
- 4) Push the trigger block safety to the “off” or “fire” position with the red dot showing. See **Figure 31**.
- 5) Squeeze the trigger. The pistol will fire when you pull or squeeze the trigger with the required force.
- 6) The pistol will fire one shot with every squeeze of the trigger, until the magazine is empty. See **Figure 32**.
- 7) When the magazine is empty, the slide will stay open. You may remove the magazine and reload the magazine while the slide is locked open by the slide stop. See **Figure 33**.
- 8) Insert the loaded magazine into the pistol. You may either press down on the slide stop or pull slightly back on the slide and release it. The slide will close and reload the chamber. The pistol will then be ready to FIRE. See **Figures 34a** and **34b**.



**Figure 29**



**Figure 30**



**Figure 31**



**Figure 32**



**Figure 34a**



**Figure 34b**



**Figure 33**

## **WARNING**

If you fired the pistol and wish to stop firing, immediately push the trigger block safety to the “on” or “safe” position. Then follow the unloading instructions above while keeping the muzzle pointed in a safe direction.



**DIRECTIONS FOR DISASSEMBLY /  
RE-ASSEMBLY OF STANDARD MODELS  
COMPACT, FULL SIZE, STEEL AND POLY:**

1) Make sure the pistol is unloaded (**FOLLOW UNLOADING INSTRUCTIONS**) and pointed in a safe direction.



Figure 35

2) Pull the hammer back to the full cock position. See **Figure 35**.



Figure 36

3) Identify the two takedown marks behind the safety lever on the left side of the slide and frame. Pull the slide back slightly and line up the two marks. See **Figure 36**. HINT: Use the rear sight for leverage when lining up the marks.



Figure 37a



Figure 37b

4) Remove the slide stop-takedown lever by pushing on the end sticking out of the right side of the pistol and pull on the lever with your other hand. See **Figures 37a** and **37b**.

6) Slide the Barrel / Slide Assembly forward and off the receiver. See **Figure 38**.



Figure 38

7) Hold the slide upside down. Retract the recoil spring and guide and remove the recoil spring and guide as an assembly. See **Figure 39**.



Figure 39

8) Remove the barrel from the slide. See **Figures 40a** and **40b**.

9) NO FURTHER DISASSEMBLY of the pistol is recommended unless performed by a qualified gunsmith. Remember that work done by others and unauthorized gunsmithing by non-factory personnel will **VOID** the warranty.

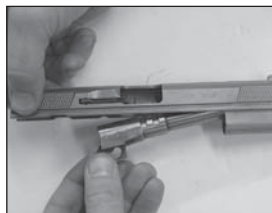

Figure 40a



Figure 40b

10) To reassemble the pistol, simply reverse these procedures.

# **DISASSEMBLY AND ASSEMBLY OF THE WITNESS LIMITED, WITNESS PCARRY AND WITNESS HUNTER PISTOLS**

1) Field Stripping. DO NOT USE TOOLS. DO NOT pry or hammer on the pistol.

2) Pull the hammer back to the full cock position. See **Figure 41**.

3) Identify the two takedown marks behind the safety lever on the left side of the slide and frame. Pull the slide back slightly and line up the two marks. HINT: Use the rear sight for handy leverage when lining up the marks. See **Figure 41**.

4) Remove the slide stop-takedown lever by pushing on the end sticking out of the right side of the pistol and pull on the lever with your other hand. See **Figures 42a** and **42b**.

5) Slide the Barrel / Slide Assembly forward and off the receiver. See **Figure 43**.

6) Hold the slide upside down, retract the recoil spring and remove the recoil spring and guide. See **Figure 44**.

7) After removing the recoil spring and guide there is a bushing in the dust cover that retains the recoil spring. This is removed by pushing it back towards the breech face. See **Figure 45**.

8) Then remove the barrel by pushing it forward. It can then be removed then from the front of the slide. See **Figure 46**.



**Figure 41**



**Figure 42a**

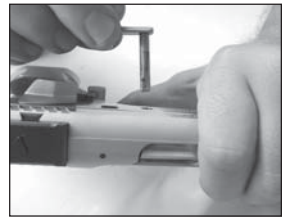

**Figure 42b**



**Figure 43**



**Figure 44**



**Figure 45**



**Figure 46**

## **DISASSEMBLY AND ASSEMBLY OF WITNESS GOLD TEAM**

1) Field Stripping. **DO NOT USE TOOLS. DO NOT pry or hammer on the pistol.**

2) Pull the hammer back to the full cock position.

3) Identify the two takedown marks behind the safety lever on the left side of the slide and frame. Pull the slide back slightly and line up the two marks. **HINT:** Use the rear sight for handy leverage when lining up the marks. See **Figure 47**.

4) Remove the slide stop-takedown lever by pushing on the end sticking out of the right side of the pistol and pull on the lever with your other hand. See **Figures 48a** and **48b**.

5) Slide the Barrel / Slide Assembly forward and off the receiver. See **Figure 49**.

6) After the slide is removed from the frame, hold the slide upside down in your left hand. Put your left thumb on the bottom barrel lug and push the barrel and recoil spring forward. You will see a small hole in the guide rod. With your right hand you will need to put a slave pin in the hole. Then release your hold on the barrel. This will trap the recoil spring, guide and bushing and make it one piece. See **Figures 50a** and **50b**.

7) Then remove the recoil spring and guide by pulling the unit out toward the breech face. See **Figure 51**. Remember this spring is compressed and only held in by your slave pin.



**Figure 47**



**Figure 48a**



**Figure 48b**



**Figure 49**



**Figure 50a**



**Figure 50b**



**Figure 51**

8) Now remove the compensated barrel by pulling it forward out of the end of the slide. See **Figure 52**.



**Figure 52**

## **SAFE USE OF PORTED AND COMPENSATED PISTOLS**

If you are shooting our WITNESS EA Standard Steel Ported, Poly Ported models or our Competition Compensated Gold Team, Silver Team or Carry Comp pistols in 9mm, 40S&W, .38super, .45ACP, or 10mm you should always wear shooting glasses and hearing protection while shooting these pistols. Gases and small particles of powder may be blown through these openings. You should never shoot these pistols from your side or close to any spectators. See **Figure 53** for an example of a ported barrel and **Figure 54** for an example of a compensated barrel.



**Figure 53**

### **MANUFACTURER'S WARNING:**

This firearm was manufactured to properly perform with the original parts as designed. It is your duty to make sure any parts you buy are correctly installed and that neither replacements nor originals are altered or changed. Your gun is a complex tool with many parts that must relate correctly to other parts for safe and accurate operation. Putting a gun together wrong or with modified parts can result in a damaged gun, or personal injury or death to you or others. Always let a qualified gunsmith work on your gun or at least, check any work not performed by a gunsmith. Firearms safety is your primary concern. **THE GUN OWNER MUST ACCEPT FULL RESPONSIBILITY FOR THE CORRECT REASSEMBLY AND FUNCTIONING OF THE FIREARM AFTER ANY DISASSEMBLY OR REPLACEMENT OF PARTS.**



**Figure 54**

## **TO CLEAN AND MAINTAIN YOUR PISTOL:**

- A) Follow procedures for unloading pistol as described previously.
- B) Follow procedures for disassembly of pistol as described previously.
- C) Materials needed to clean this pistol are: a cleaning rod, cotton bore patches, brass bore brush, powder solvent, a small soft brush and good quality gun oil.

**WARNING:** Lead or lead compounds are known to the State of California to cause cancer, birth defects, reproductive toxicity, and other serious physical

injury. Those who clean firearms should take protective measures to avoid contact or exposure to such chemicals.

**D)** Using the bore brush with powder solvent, scrub the interior of the barrel and chambers to remove any powder and lead residue in the bore. Always and lastly, swab the interior of the barrels with cotton patch with gun oil to coat and protect the bore and chambers from rust and corrosion.

**E)** Any powder fouling on the firing wall, barrel, etc. can be easily cleaned with a brush and powder solvent.

**F)** All external surfaces should be wiped down with a light coat of rust preventative. Avoid using too much oil as powder, dust or other foreign material may get trapped in the oil. This could lead to congealed deposits which may interfere with the safe and reliable operation of the pistol.

**G) USE CAUTION** while using solvents in gun bore cleaning. Prolonged or excess contact with solvents can damage the gun's bluing and finish. Be sure to wipe away all excess solvent and then lubricate with oil.

**H)** A gun should be cleaned after firing. In addition, external parts should be wiped with an oiled cloth after handling. A light oil is ordinarily all that is necessary in cleaning if the gun has not been fired or fired very little. If a gun is used frequently, it must be cleaned after each firing and regularly serviced by a professional gunsmith. If the gun has been stored, remove all excess oil and/or grease before firing. Always check to be sure that no cleaning patch or other obstruction remains in the bore or chambers before firing.

## **DANGER – AMMUNITION WARNING**

Firearms may be damaged and serious personal injury or death to the shooter or bystanders may result from any condition which contributes to the generation of excessive pressure or uncontrolled release of gas within the firearm. Such adverse conditions can be caused by bore or chamber obstruction, propellant powder overloads or by defective, incorrect or improperly loaded and assembled cartridge components. Even the strongest firearm can be blown up as a result of excessive pressure. It is extremely dangerous to use a cartridge whose pressure is greater than that developed by cartridges loaded to industry standards.

## **AMMUNITION (CARTRIDGES) NOTICE**

We specifically disclaim responsibility for any damage, personal injury or death occurring in connection with or as the result of the use of European American Armory Corp. pistols with faulty, nonstandard, remanufactured, hand-loaded or reloaded ammunition, or with cartridges other than factory cartridges for which the firearm was originally chambered.

## **LUBRICATION WARNING**

Firing a pistol with oil, grease or any other material even partially obstructing the bore may result in damage to the pistol and personal injury to the shooter and those nearby. Do not spray or apply lubricants directly on ammunition. If the primer or powder charge of a cartridge is affected by the lubricant, they may not fully ignite yet the energy from the primer and/or powder may be sufficient to push the projectile or wad into the bore where it may become lodged. Firing a subsequent cartridge into the obstructed bore will damage the pistol and may cause personal injury to the shooter and those nearby. Use lubricants properly. You are responsible for the proper care and maintenance of your firearm and ammunition.

## **LIMITED LIFETIME WARRANTY**

This European American Armory Corp. firearm is warranted to the original retail customer for Life from date of purchase against defects in material and workmanship. All parts and labor or replacement **at our option** are covered. **Transportation to and from our repair facilities**, government fees, damage caused by failure to perform normal maintenance, sales outside the United States, damage due to use of high velocity, high pressure, reloaded or other nonstandard ammunition, or any unauthorized repair, modification, misuse, abuse, or alteration of the product is not covered by this Limited Warranty.

Any implied warranties, including the implied warranties of merchantability and fitness for a particular purpose, are limited to one year from date of original retail purchase. Consequential or incidental damages and/or expenses, or any other expenses are not covered by this warranty.

To obtain warranty performance send your firearm with proof of retail purchase, freight prepaid plus \$20.00 for return freight to:

**European American Armory Corp**  
**1426 King Street**  
**Cocoa, FL 32922**  
**Phone: (321) 639-4842**

**NOTICE:** It is illegal to ship a firearm with ammunition in the firearm or in the same packaging. Firearms and ammunition must be shipped separately. For information about shipping ammunition, call European American Armory Corp. at (321) 639-4842.

## **WARNING—ALTERATIONS OR MODIFICATIONS**

Altering or modifying parts and/or internal safeties is dangerous and will void the warranty. This pistol was manufactured to perform properly with the original parts as designed. It is your duty to make sure any parts you buy are made for this firearm and are installed correctly and that neither the replacements nor originals are altered or changed. Your gun is a complex precision tool with many parts that must relate correctly to other parts in order for proper and safe operation. Putting

a gun together wrong or with incorrect or modified parts can result in a damaged gun, danger, and personal injury or death to you and others through malfunction. Always have a qualified gunsmith work on your gun or at least check any work not performed by a gunsmith.

## **YOUR OWNER'S MANUAL**

Always keep this manual with your firearm. Make sure you understand all the warnings, operation instructions and safety procedures. When you lend, give or sell the firearm, be sure this manual goes with it. You can get a copy of this manual from European American Armory Corp. upon request.

**ALL PARTS ORDERS ARE SUBJECT TO A \$10.00 CHARGE FOR SHIPPING AND HANDLING.** Please state Model, Caliber, Serial Number, and Finish Color when ordering. For parts, information and service contact: European American Armory Corp., 1426 King Street, Cocoa, FL 32922 Phone: (321) 639-4842

## WITNESS PARTS EXPLOSION

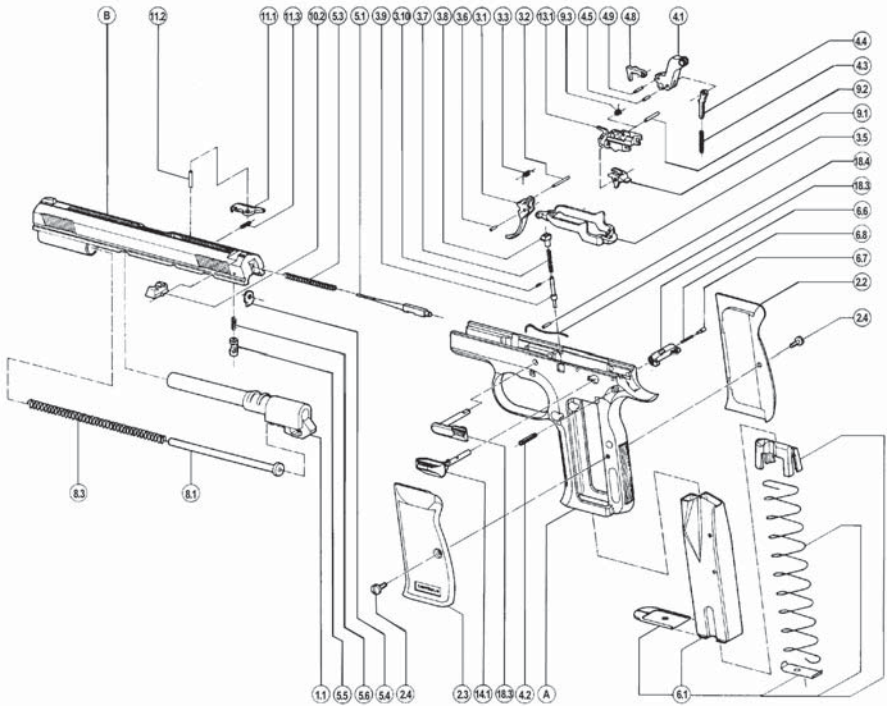

### WITNESS PARTS LIST

- |   |  |
|---|--|
| <p>1.1 BARREL</p> <p>2.2 RIGHT GRIP</p> <p>2.3 LEFT GRIP</p> <p>2.4 GRIP SCREWS</p> <p>3.1 TRIGGER</p> <p>3.2 TRIGGER PIN</p> <p>3.3 TRIGGER SPRING</p> <p>3.5 TRIGGER BAR</p> <p>3.6 TRIGGER BAR PIN</p> <p>3.7 TRIGGER BAR SPRING</p> <p>3.8 TRIGGER BAR GUIDE</p> <p>3.9 TRIGGER BAR PLUNGER</p> <p>3.10 TRIGGER BAR PLUNGER PIN</p> <p>4.1 HAMMER</p> <p>4.2 HAMMER PIN</p> <p>4.3 HAMMER SPRING</p> <p>4.4 HAMMER STRUT</p> <p>4.5 HAMMER STRUT PIN</p> <p>4.8 INTERRUPTOR</p> <p>4.9 INTERRUPTOR PIN</p> <p>5.1 FIRING PIN</p> <p>5.3 FIRING PIN SPRING</p> <p>5.4 FIRING PIN RETAINER</p> <p>5.5 FIRING PIN SAFETY</p> <p>5.6 FIRING PIN SAFETY SPRING</p> | <p>6.1 MAGAZINE</p> <p>6.6 MAGAZINE CATCH</p> <p>6.7 MAGAZINE CATCH PLUNGER</p> <p>6.8 MAGAZINE CATCH SPRING</p> <p>8.1 RECOIL SPRING GUIDE</p> <p>8.3 RECOIL SPRING</p> <p>9.1 SEAR</p> <p>9.2 SEAR PIN</p> <p>9.3 SEAR SPRING</p> <p>10.2 REAR SIGHT</p> <p>11.1 EXTRACTOR</p> <p>11.2 EXTRACTOR PIN</p> <p>11.3 EXTRACTOR SPRING</p> <p>13.1 SEAR ASSEMBLY HOUSING<br/>WITH EJECTOR</p> <p>14.1 SAFETY</p> <p>18.1 SLIDE STOP PIN</p> <p>18.3 SLIDE STOP PIN SPRING</p> <p>18.4 SLIDE STOP PIN SPRING PIN</p> <p>A FRAME</p> <p>B SLIDE</p> |
|---|--|



## WITNESS P PARTS EXPLOSION

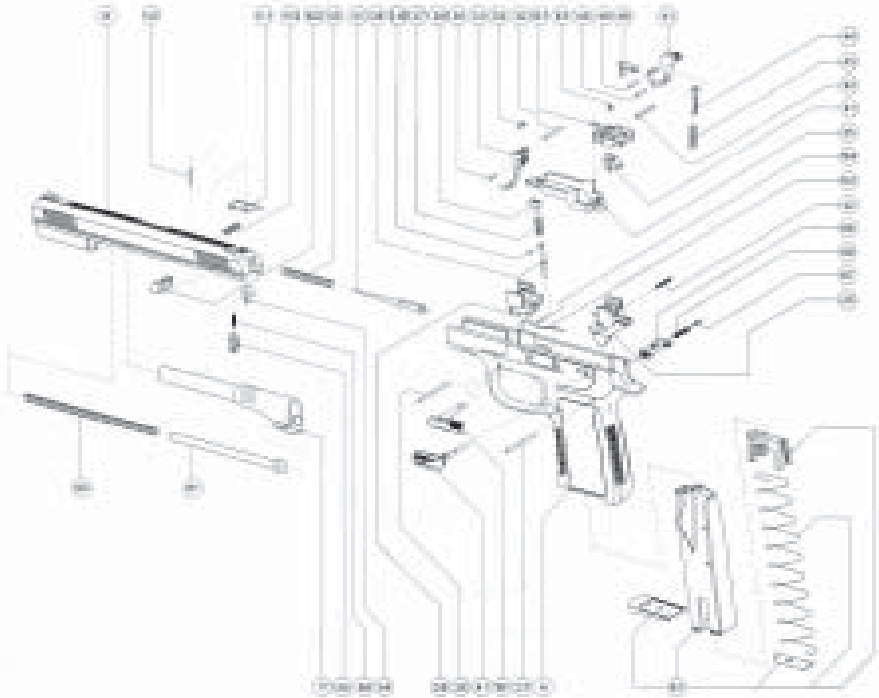

### WITNESS P PARTS LIST

- |                              |                                |
|------------------------------|--------------------------------|
| 1.1 BARREL                   | 6.1 MAGAZINE                   |
| 2.5 P REAR INSERT            | 6.6 MAGAZINE CATCH             |
| 2.6 P FRONT INSERT           | 6.7 MAGAZINE CATCH PLUNGER     |
| 2.7 P REAR INSERT PIN        | 6.8 MAGAZINE CATCH SPRING      |
| 2.8 P FRONT INSERT PIN       | 8.1 RECOIL SPRING GUIDE        |
| 3.1 P TRIGGER                | 8.3 RECOIL SPRING              |
| 3.2 P TRIGGER PIN            | 9.1 SEAR                       |
| 3.3 TRIGGER SPRING           | 9.2 SEAR PIN                   |
| 3.5 TRIGGER BAR              | 9.3 SEAR SPRING                |
| 3.6 TRIGGER BAR PIN          | 10.2 REAR SIGHT                |
| 3.7 TRIGGER BAR SPRING       | 11.1 EXTRACTOR                 |
| 3.8 TRIGGER BAR GUIDE        | 11.2 EXTRACTOR PIN             |
| 3.9 TRIGGER BAR PLUNGER      | 11.3 EXTRACTOR SPRING          |
| 3.10 TRIGGER BAR PLUNGER PIN | 13.1 SEAR HOUSING              |
| 4.1 HAMMER                   | 14.1 P SAFETY                  |
| 4.2 P HAMMER PIN             | 18.1 SLIDE STOP PIN            |
| 4.3 HAMMER SPRING            | 18.3 SLIDE STOP PIN SPRING     |
| 4.4 HAMMER STRUT             | 18.4 SLIDE STOP PIN SPRING PIN |
| 4.5 HAMMER STRUT PIN         | A FRAME                        |
| 4.8 INTERRUPTOR              | B SLIDE                        |
| 4.9 INTERRUPTOR PIN          |                                |
| 5.1 FIRING PIN               |                                |
| 5.3 FIRING PIN SPRING        |                                |
| 5.4 FIRING PIN RETAINER      |                                |
| 5.5 FIRING PIN SAFETY        |                                |
| 5.6 FIRING PIN SAFETY SPRING |                                |

 **WARNING**

Children are attracted to and can operate firearms that can cause severe injuries or death.

Prevent child access by always keeping guns locked away and unloaded when not in use. If you keep a loaded firearm where a child obtains and improperly uses it, you may be fined or sent to prison.

 **ADVERTENCIA**

A los niños les atraen las armas de fuego y los pueden hacer funcionar. Ellos pueden causarse lesiones graves y la muerte.

Evite que los niños tengan acceso a las armas de fuego guardándolas siempre con llave y descargadas cuando no las esté utilizando. Si usted tiene un arma de fuego cargada en un lugar en que un niño tiene acceso a ella y la usa indebidamente, le pueden dar una multa a enviarlo a la cárcel.

**Importer:**

**European American Armory Corp**  
**1426 King Street**  
**Cocoa, FL 32922**  
**Phone: (321) 639-4842**

**Manufacturer:**

Fratelli Tanfoglio, S.n.c.  
Via Valtrompia 39/41  
25063 Gardone V.T.  
Brescia, Italy