EAA MODEL MP133 PUMP ACTION SHOTGUN (12 GA)



WARNINGS AND INSTRUCTION MANUAL

European American Armory Corp.
1426 King Street
Cocoa, FL 32922

(321) 639-4842

www.eaacorp.com

E-mail: eaacorp@eaacorp.com

© Copyright 2004

EAA MODEL: MP133 PUMP ACTION SHOTGUN

WARNINGS AND INSTRUCTION MANUAL PLEASE READ THESE INSTRUCTIONS

MODEL NUMBER MP133	BARREL LENGTH 20", 24", 26", 28"	GAUGES 12 / 3.5"
TYPE PUMP ACTION SHOTGUN		FINISH BLUE

GENERAL INFORMATION:

Weight (average) - 20" = 5.9Lbs., 28" = 6.7Lbs.

Overall Length - 40" to 48"

Capacity - 4+1 @ 12 Ga. / 3.5"

FOR YOUR SAFETY AND THE SAFETY OF OTHERS, this owner's manual contains important warnings, instructions and safety procedures which must be understood **BEFORE** using this firearm. Read the **ENTIRE MANUAL** and if you do not understand any part of it or the operation of your shotgun, stop and seek professional firearms instructions. You can get a copy of this manual from European American Armory Corp. upon request.

Record the serial number of your firearm (located inside the receiver on the right hand side):

and a description of it:

Make a copy of this manual, proof of purchase/sales record for safekeeping in a secure safe or fireproof container. Such proof is necessary if the firearm is damaged, stolen or sent in for warranty repair.

 **W A R N I N G**
****YOU RISK PERSONAL INJURY OR DEATH
BY HANDLING THIS FIREARM****

Before handling any firearm, make sure you know the safety procedures and most importantly, keep the firearm pointed in a safe direction.

Before handling this firearm, read, understand and follow the instructions in this manual. Always keep this manual with the firearm. If you lend, give or sell this firearm, be sure the manual goes with it. If there is anything you do not understand, seek advice from someone qualified in safe handling of firearms. You must ALWAYS obey the following warnings, instructions and safety procedures:

1. Always keep the muzzle pointed in a safe direction.
2. Firearms should be unloaded and secured when not actually in use.
3. Don't rely on your firearm's safety.
4. Be sure of your target and what's beyond it.
5. Use only proper ammunition matching the precise size and gauge of your specific pump action shotgun.
6. If your pump action shotgun fails to fire when the trigger is pulled, handle with care.
7. Always wear ear and eye protection when shooting.
8. Be sure the barrel is clear of obstructions before shooting.
9. Don't alter or modify your firearm and have it serviced regularly.
10. Learn the mechanical and handling characteristics of your pump action shotgun.
11. Shoot sober!

Type Of Ammunition To Be Used

It is suggested that high quality commercially manufactured ammunition be used in this firearm. Avoid military surplus or old ammunition as it may not fire with sufficient force to expel the projectile or wad from the barrel. **The use of reloaded, high pressure or hand-loaded ammunition can be dangerous and will void the warranty.**

LEAD WARNING: The actual firearm does not contain any lead; however, it does fire ammunition which contains lead or lead compounds known to the State of California to cause cancer, birth defects, reproductive toxicity, and other serious physical injury. Those who discharge a firearm, stand near someone who discharges a firearm or clean firearms are hereby warned of the dangers presented by lead and lead compounds and should take protective health measures. Avoid exposure to lead while handling and wash your hands after contact. Proper air ventilation is absolutely necessary when shooting indoors.

NOTICE

PUMP ACTION SHOTGUNS ARE CLASSIFIED AS FIREARMS OR DANGEROUS WEAPONS and are sold by European American Armory Corp. with the specific understanding that we are not responsible in any manner whatsoever for their safe handling or resale under local laws and regulations.

European American Armory Corp. shall not be responsible in any manner whatsoever for malfunctioning of the firearm, for physical injury or for property damage resulting in whole or in part from **(1)** intentional or negligent discharge, **(2)** improper or careless handling, **(3)** unauthorized modifications and/or alteration of the internal/safety mechanisms, **(4)** defective, improper, high pressure, hand-loaded, or reloaded ammunition, **(5)** corrosion and/or lack of proper maintenance, **(6)** neglect, or **(7)** other influences beyond our direct and immediate control. This limitation applies regardless of whether liability is asserted on the basis of contract, negligence or strict liability (including any failure to warn). Under no circumstance shall European American Armory Corp. be liable for incidental or consequential damages, such as loss of use of property, commercial loss and loss of earnings or profits.

FOLLOWING THESE SAFETY RULES CAN SAVE YOUR LIFE OR THE LIFE OF SOMEONE ELSE

Get competent firearms instruction in safe handling before using this firearm. Please ask your dealer for names of qualified instructors near you. All guns are extremely dangerous if carelessly handled or used. Remember that the firearm user is the primary "safety" and that reliance on any mechanical safety device should never replace safe handling procedures.

This firearm WILL FIRE if a shell is in the chamber and the trigger is pulled while the safety is disengaged.

DO NOT LOAD THIS PUMP ACTION SHOTGUN UNTIL YOU UNDERSTAND HOW IT OPERATES. KEEP this pump action shotgun unloaded at all times except when you are ready to fire and are sure of your target.

ALWAYS carry this pump action shotgun in a case or original box unloaded.

NEVER point this pump action shotgun at anything that is not your intended target even if the pump action shotgun is unloaded. When loading, unloading, cleaning or handling, always be sure the muzzle is pointed in a safe direction and always keep your finger off the trigger.

NEVER assume any gun is unloaded. Before handling, check to make sure the chamber is empty. See Unloading Instructions. Make sure you know that this or any firearm is fully unloaded before displaying or handling it. When handling any firearm, keep your fingers away from the trigger at all times until you intend to fire.

Get instructions from a competent firearms instructor before using this or any firearm. Learn from a professional how to handle, load, unload, operate, fire and care for your gun.

NEVER PLAY with your firearm. It is not a toy and can be a very dangerous weapon that can cause serious personal injury or death.

Always keep the gun pointed in a safe direction. Treat every gun as if it is loaded...all the time. **NEVER** point any firearm (loaded or unloaded) at any person or anything you do not intend to shoot. Always keep your gun unloaded until ready to use and make sure that it is unloaded before cleaning.

Keep your finger **OFF** the trigger until you are actually aiming at the target and ready to shoot. Learn to rest your finger outside of the trigger guard.

Never rely on a gun's "safety" to protect you from unsafe gun handling. A safety is only a mechanical device, not a substitute for using common sense and following gun safety procedures.

FOLLOWING THESE SAFETY RULES CAN SAVE YOUR LIFE OR THE LIFE OF SOMEONE ELSE

Never leave a gun unattended or where it could fall.

Store guns and ammunition separately **beyond the reach of children**. Make sure that they are properly secured so untrained individuals and children will be denied access to your guns and ammunition.

Test your gun's operation and safeties only at a shooting range while the firearm is pointed in a safe direction.

Know your target and what is beyond. Ask yourself what your projectile will hit if it misses the target or passes through the intended target. Remember, a fired projectile can travel over a mile (including a ricochet) and is capable of going through walls. Never shoot at hard flat surfaces or water. . . bullets ricochet.

Guns and alcohol or drugs do not mix. Don't take any alcoholic beverages and/or drugs before or during shooting activities.

Never pull a gun toward you by the muzzle. Don't climb a tree, cross a ditch or fence with a loaded gun.

Always empty guns before entering a house, car, truck, boat, RV, camp or any building.

When receiving a gun, always open the action and check to make sure the chamber is unloaded.

NEVER accept anyone's word that a gun is "unloaded" or "empty." You should immediately open the action and check to make sure it is unloaded.

Be careful with **ALL** ammunition. Even "blank" cartridges are deadly at close range due to the muzzle blast. Make sure your ammunition is new and in good clean condition. Do **NOT** oil or grease ammunition as this may damage the cartridge primer. Do **NOT** tamper with or alter the standard factory ammunition.

Keep firearms unloaded when not actually in use. Load the gun only when on the range preparing to fire and unload it before leaving the range.

Never put your hand over the muzzle of a gun.

ALWAYS WEAR protective shooting glasses and hearing protection when using firearms.

FOLLOWING THESE SAFETY RULES CAN SAVE YOUR LIFE OR THE LIFE OF SOMEONE ELSE

Spectators should be at least 10 feet behind and away from the shooter while the shooter is loading, shooting and unloading. Spectators should wear protection for hearing and sight loss and they should avoid distracting those shooting their firearms.

Never drop your gun. If you do drop it, unload it and check it for proper function before using it again.

Do **NOT** alter or modify your gun. Don't try to change your gun's trigger pull, because it may affect sear engagement and thereby cause accidental firing.

Do **NOT** remove any internal safety or safety device on the firearm. Safety mechanisms are designed to help protect you from injury or death.

Properly maintain and keep your gun clean. Keep in a dry place away from other metals and water. If your gun shows sign of corrosion or improper operation, have it serviced by a competent gunsmith.

Keep the muzzle pointed in a safe direction when loading and unloading your gun. Never point the muzzle at anyone.

If a gun fails to fire when the trigger is pulled, keep it pointed down range at the target for 60 seconds. Sometimes slow primer ignition may cause a delay in full ignition of a cartridge. If after 60 seconds the cartridge does not fire, keep the muzzle pointed in safe direction and avoid exposure to the breech, as you attempt to unload your firearm.

Never let water, snow, mud or other material enter the barrel. Always be sure the barrel is free of any obstruction.

Since many ammunition identifications sound similar, be sure that you use only the correct ammunition for your gun. Do **NOT** use the wrong size or wrong strength ammunition in your firearm.

Teach children: 1. **NOT** to touch guns, bullets, cartridges, shells, flares or any explosive device and 2. That if they discovery such a dangerous item or weapon, they must immediately report its location to their parents, school teacher or police.

Remember a firearm has the capability of taking your life or the life of someone else. Be careful with your firearm — an accident is almost always the result of not following basic safety rules.

Use the Security Lock Provided with your Pump action shotgun

This pump action shotgun comes with a security lock to assist in protecting against unauthorized use. See **Figure 1**. The pump action shotgun must be unloaded when the security lock is in place on the pump action shotgun. **WARNING:** Using the security lock cannot substitute for securing your firearm and ammunition in separate, locked locations.

The security lock operates as follows:

1. To open the Trigger Lock put the Key into the notches of the Trigger Lock Nut and unscrew it counter-clockwise. See **Figure 2**. Remove the Trigger Lock Screw.



Figure 1

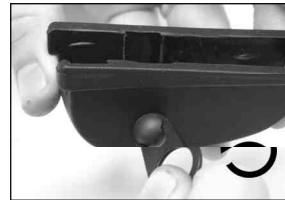

Figure 2

2. To install the Trigger Lock on a pump action shotgun put the Trigger Lock over the trigger guard with the smaller end of the Trigger Lock shroud pointing toward the muzzle. Then place the Trigger Lock Screw through the cross-slotted hole on the side of the Trigger Lock shroud. See **Figures 3a, 3b**.



Figure 3a

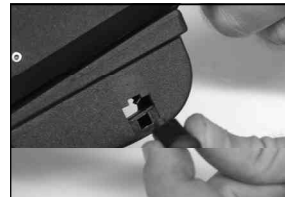

Figure 3b

3. Screw the Trigger Lock Nut on the Trigger Lock Screw (clockwise) and tighten the nut with the key. **DO NOT TIGHTEN THE NUT TOO TIGHT OR YOU COULD DAMAGE THE LOCK SCREW.** See **Figure 4**.



Figure 4

4. To remove the Trigger Lock, unscrew the Trigger Lock Nut with the key and detach the Trigger Lock Screw. See **Figure 5**.

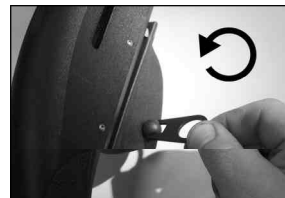

Figure 5

! WARNING

Always store the key to the security lock: (1) in a separate location away from the pump action shotgun; (2) in a secure location unknown and not accessible to others, especially children. Whether you secure your firearms by using the supplied security lock, a gun lock or safe or some other mechanism, it is **YOUR RESPONSIBILITY** to store your firearms in such a manner that children and other unauthorized persons cannot gain access to them.

USED FIREARMS - Firearms are sometimes altered to work incorrectly, or parts may be removed, lost or replaced with incorrect parts. If you got your European American Armory Corp. firearm as a used gun, **BEFORE USING IT** you should take it to a good gunsmith who knows European American Armory Corp. firearms, and have him examine it.

WRITE EUROPEAN AMERICAN ARMORY CORP. concerning any items or circumstances which you don't understand and which might relate to your safety and the operation of your firearm at: European American Armory Corp., 1426 King Street, Cocoa, FL 32922 Phone: (321) 639-4842.

 **W A R N I N G (POTENTIAL OBSTRUCTIONS)**

BEFORE LOADING or firing a pump action shotgun, examine the bore and the firing chamber to be certain they are clean and free of any obstruction. Even a heavy coat of oil, grease, snow or water may result in damage to the firearm and injury to the shooter and/or persons near the firearm. A misfire or unusual sound upon firing is a signal to cease firing and to examine the chamber and bore. If there is any obstruction, clear the obstruction and clean the bore and chamber before firing.

Any bore obstruction, even if it is only partly blocked, may cause the gun to blow up if it is fired, or may cause damage to the gun such as a bulged barrel. To avoid injury or death to the shooter or bystanders, check the barrel before shooting or if a shot does not sound normal.

 **W A R N I N G**

Always keep the muzzle pointed in a safe direction! Never attempt to load or unload any firearm inside a vehicle, building or other confined space (except a properly constructed shooting range). Enclosed areas frequently offer no completely safe direction in which to point the firearm. If an accidental discharge occurs, there is great risk of death, personal injury or property damage. Before loading, always clean all, grease and oil from the bore and chamber, and check to be certain that no obstruction is in the barrel. Any foreign matter in the barrel could result in a bulged or burst barrel or other damage to the firearm and could cause serious injury to the shooter or to others.

 **W A R N I N G**

If there is any reason to suspect that a projectile or any other object is obstructing the barrel, immediately unload the firearm (See Unloading Instructions) and check the chamber and the bore. A wad, shot or some other matter that may be lodged some distance down the barrel where it can not easily be seen. Check the bore by using a cleaning rod to pass through the barrel. If a blockage is in the bore, **DO NOT ATTEMPT TO SHOOT IT OUT WITH ANOTHER CARTRIDGE, OR BLOW IT OUT WITH A BLANK CARTRIDGE OR A CARTRIDGE FROM WHICH THE SHOT HAS BEEN REMOVED. SUCH TECHNIQUE(S) CAN GENERATE EXCESSIVE PRESSURE, DAMAGE THE FIREARM AND CAUSE SERIOUS**

PERSONAL INJURY. If the blockage can be removed with a cleaning rod, clean any unburned powder grains from the bore, chambers and mechanism before resuming shooting. If the blockage can not be dislodged by tapping it with a cleaning rod, take the firearm to a gunsmith.

⚠ WARNING (EYE AND EAR PROTECTION)

When shooting, full eye and ear protection is mandatory at all times. Shooters and spectators must wear shooting glasses and hearing protection to prevent eye injury and hearing loss. Vision and hearing impairment can occur with only one moment of non-protection.

⚠ WARNING (Mechanical Malfunctions)

STOP SHOOTING IMMEDIATELY AND UNLOAD YOUR FIREARM if your firearm develops: a mechanical malfunction; binding or stoppage; spitting powder/gas; a punctured cartridge primer; a bulged or ruptured cartridge case; or a sound on firing does not sound quite right. Do **NOT** try one more shot but unload your firearm and take it and the ammunition to a qualified gunsmith or send the firearm back to European American Armory Corp. for examination. Do not assume that the pump action shotgun is empty merely because you checked the chamber. You must also check the bore for any fired shot or wad jammed inside the barrel.

BASIC PARTS OF YOUR PUMP ACTION SHOTGUN

EXTERNAL CONTROL PARTS:

Cross Trigger Block Safety: The safety mechanism of the pump action shotgun provides protection against accidental and unintentional discharge under normal usage when properly engaged and in good working order. The safety mechanism is not a substitute for following the rules of safe gun handling. Do not disengage the safety unless you are ready to fire the pump action shotgun. **MAKE SURE YOU UNDERSTAND HOW THE SAFETY WORKS BEFORE YOU LOAD OR USE THE PUMP ACTION SHOTGUN.**

The safety mechanism is a push-button-style safety located on the trigger housing behind the trigger. See **Figure 6**. To place the safety in the “on” or “safe” position, push the button all the way to the right. When in the “on” or “safe” position, the safety blocks the rearward motion of the trigger. To place the safety in the “off” or “fire” position, push the slide button all the way to the left. When in the “off” or “fire” position, a red circle is exposed behind the slide button. You have now disengaged the safety and the pump action shotgun is in the ready-to-fire position. See **Figure 7**.



Figure 6



Figure 7

⚠ WARNING!

Do not touch the trigger while moving the safety. When operating the safety, make sure you push it to the full extent of its travel in the desired direction, either fully “on” or fully “off.” Half-safe or partially-safe is **UNSAFE**.

Trigger: The trigger is located in the trigger guard. If the trigger is pulled to the rear and the safety is disengaged and a cartridge is chambered, the pump action shotgun will discharge. See **Figure 8**.

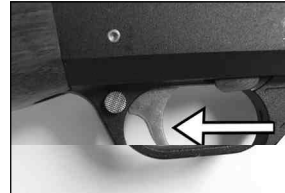

Figure 8

⚠ WARNING!

Never pull the trigger until you are actually ready to fire. Keep your fingers off the trigger and outside of the trigger guard until you are ready to pull the trigger and fire the pump action shotgun. When opening and closing the action and when engaging or disengaging the safety mechanism, make sure your fingers are outside the trigger guard and away from the trigger.

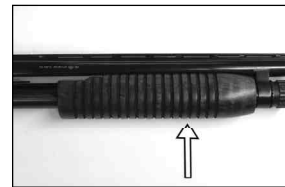

Figure 9

Forearm/Slide: The forearm/slide is located under the barrel in front of the receiver. See **Figure 9**. The forearm/slide moves rearward to remove spent or empty cartridge casings. The forearm/slide also removes live cartridges that were chambered. It also extracts a round from the magazine and moves forward to pick up a live cartridge from the carrier and push it into the firing chamber.

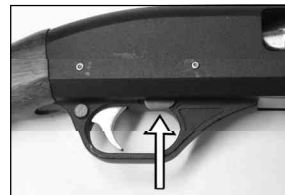

Figure 10

Action Unlock Button The action unlock button, when pushed up, will allow the slide to open for quick visual inspection of the chamber and unloading of the chamber. See **Figure 10**.

Carrier Release Button: The carrier release button is located on the right side of the shotgun and protrudes out of the forward right hand side of the receiver. See **Figure 11**. Pushing in the button will release the carrier for loading and unloading the magazine tube as well as allow the bolt to move to the forward position after all of the rounds have been fired. **NOTE:** This shotgun locks the bolt back after the ejection of the last round.

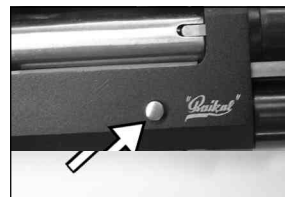

Figure 11

Magazine Tube: The magazine tube screws onto the end of the receiver and holds the cartridges for feeding into the receiver. See **Figure 12**.

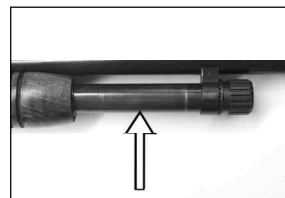

Figure 12

Magazine Cap: The magazine cap holds the barrel to the action. See **Figure 13**.

The Serial Number: The pump action shotgun's serial number is located on the lower left side of the receiver.

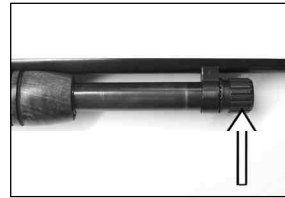

Figure 13

DIRECTIONS FOR ASSEMBLY OF PUMP ACTION SHOTGUN:

⚠ WARNING !

Before you begin to assemble the pump action shotgun, you **MUST** (1) look down the barrel from the breech end toward the muzzle end to make sure there is no ammunition in the chamber or obstruction in the barrel, and (2) make sure the safety is in the "safe" position. See **Figure 14**.



Figure 14

Your pump action shotgun was shipped with the barrel detached from the main portion of the shotgun. See **Figure 15**. To assemble the pump action shotgun, follow these instructions:



Figure 15

- 1) When you open the box of your new MP133 shotgun, the barrel is separated from the main portion of the shotgun. To attach the barrel, first remove the stock and forearm/slide assembly from the plastic bag. Then remove the magazine tube cap/extension. See **Figure 16**.



Figure 16

⚠ WARNING !

The magazine cap is under spring pressure. Note: After assembly of the shotgun the spring in the magazine tube may become twisted. This will cause a decrease in magazine tube capacity. If you load and unload the magazine tube the spring will untwist and the capacity should be as defined in the manual.

- 2) Slide the forearm/slide assembly to the middle of the slide path so that the bolt is midway in the ejection port window. See **Figure 17**.



Figure 17

- 3) Remove the barrel from the box and remove the plastic bag from the barrel. Attach the barrel by inserting the barrel extension end into the receiver and slide the forearm/slide assembly back as required so that the barrel fully enters the receiver and the barrel magazine support aligns and goes around

the magazine tube. See **Figure 18a**. Now reinstall the magazine tube cap or extension. We recommend that you have your firearms dealer show you how to do this the first time. ALWAYS make sure the magazine tube cap/extension is completely tightened. See **Figure 18b**.



Figure 18a

- 4) Once the shotgun is assembled (or if you cannot fully assemble the shotgun and plan to carry it somewhere for assistance) activate the cross trigger block safety and keep it activated until you are ready to fire the shotgun. Keep the safety on no matter if the gun is loaded or unloaded.



Figure 18b

LOADING AND UNLOADING YOUR PUMP ACTION SHOTGUN

⚠ WARNING!

Never load or fire the pump action shotgun unless the barrel is properly attached to the receiver, and the forearm/slide assembly is locked into the receiver.

⚠ WARNING!

Make sure the pump action shotgun is pointed in a safe direction and the cross trigger block safety is engaged at all times while loading and unloading. NEVER allow your finger or other objects to contact the trigger while loading or unloading.

⚠ WARNING!

Do not disengage the cross trigger block safety until you are ready to fire and have the shotgun pointed safely downrange.

***** Warning *****

Do not load the pump action shotgun until you are ready to fire

TO LOAD:

- 1) Make sure the ammunition that you are using is the correct size and gauge. The barrel is marked with the gauge and chamber size. Barrels marked 3 1/2" (89mm) will also use 2 3/4" (70mm), 3" (76mm) or 3 1/2" (89mm) shot shells.
- 2) Visually inspect the chamber and barrel for obstructions by pulling back the forearm/slide until it stops movement. Note that if the forearm/slide will not

move to the rearward position, depress the action unlock button. See **Figure 19**. The chamber and barrel should be free of oil or grease or obstructions. See **Figure 20**.



Figure 19

- 3) After inspection, with the bolt in the rearward position, depress the carrier release button to allow the bolt to move forward on an empty chamber. See **Figure 21**. Turn the shotgun on its side and insert four or less cartridges into the magazine tube. See **Figure 22**. Then depress the action unlock button and move the bolt rearward. This will free a cartridge from the magazine tube. See **Figure 23**. Then push the forearm assembly forward. The shotgun is now loaded. Repeat this action to shoot all the ammunition in the magazine tube.

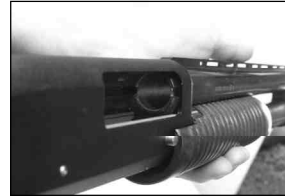

Figure 20

- 4) With the bolt in the rear position and the safety on you can load your shotgun by inserting one round into the ejection port. Then depress the carrier latch button to release the bolt. Then sliding the forearm/slide assembly forward until the action locks. The shotgun will now fire if the cross trigger block safety is disengaged and the trigger is pulled.



Figure 21



Figure 22

TO UNLOAD:

- 1) Make sure the shotgun is pointed in a safe direction and the cross trigger block safety is engaged.
- 2) Depress the action unlock button and slide the forearm/slide assembly rearward. See **Figure 23**. The bolt should move to the rearward location and if there was a round in the chamber it should be ejected. Once ejected, leave your finger on the action unlock button and push the next round into the chamber. Then move the fore end slide assembly rearward again, repeat this until the magazine tube is empty. The bolt will lock in the rearward position when the magazine tube is empty. See **Figures 24 and 25**.



Figure 23



Figure 24



Figure 25

- 3) Visually inspect the chamber and carrier to make sure there are no more rounds in the chamber or carrier. If there is a cartridge stuck in the chamber and it did not come out when you moved the forearm/slide assembly to the rear, obtain a cleaning rod and push the cartridge out backwards.
- 4) If there was a round in the magazine tube, the carrier will be up in the feed position after the round has been ejected from the chamber. You should have already removed the round on the carrier that came from the magazine tube in Step 2.
- 5) To manually remove the cartridges from the magazine tube, move the bolt forward or an empty chamber. Now push the carrier latch down until it stops. Then with the same finger push the shell latch inward until the first cartridge is released. Repeat this until the magazine is empty. The shell latch is a flat metal piece on the right hand side of the receiver. Also check for any debris or foreign objects in the mechanism or barrel or chamber. See **Figure 26**.
- 6) Following Steps 1 through 3 is the safest way to unload your shotgun and the procedure we recommend.



Figure 26

FIRING YOUR PUMP ACTION SHOTGUN

⚠ **WARNING**

Never load a cartridge into the chamber until you are ready to fire the pump action shotgun.

⚠ **WARNING**

Do not disengage the cross trigger block safety until the pump action shotgun is pointed in a safe direction and you are ready to fire.

⚠ **WARNING**

If a cartridge does not fire and the trigger has been pulled and the cross trigger block safety is disengaged, Stop! Then do the following: **a)** Make sure the gun is pointed in a safe direction **b)** Engage the cross trigger block safety **c)** Wait 60 seconds **d)** Follow the instructions above for unloading the pump action shotgun.

⚠ **WARNING**

If during firing the sound of any cartridge is noticeably softer or louder than the previous cartridge fired, Stop! Then do the following: **a)** Make sure the gun is pointed in a safe direction **b)** Engage the cross trigger block safety **c)** Follow the instructions above for unloading the pump action shotgun and **d)** With the pump action shotgun unloaded visually inspect the pump action shotgun for barrel

blockage or damage. Then inspect the receiver of the pump action shotgun for damage before continuing.

READ, UNDERSTAND AND FOLLOW ALL WARNINGS AND INSTRUCTIONS IN THIS MANUAL BEFORE FIRING THE PUMP ACTION SHOTGUN.

TO FIRE THE PUMP ACTION SHOTGUN:

- 1) Make sure you are wearing eye and ear protection.
- 2) Make sure the pump action shotgun is pointed in a safe direction with the trigger block safety engaged. See **Figure 27**.
- 3) Keeping your fingers away from the trigger, push the cross trigger block safety to the “off” or “fire” position with the red dot showing. See **Figure 28**.
- 4) With the butt stock held firmly against your shoulder and the barrel pointed towards your intended target, place your trigger finger on the trigger. The pump action shotgun will fire when you pull or squeeze the trigger with the requisite force. See **Figure 29**. Pump action shotguns feed the next live round from the magazine tube into the chamber each time the action is cycled.
- 5) After the last round has been fired, the forearm/slide and bolt will lock in the rearward position when cycled. Never rely on the locked back bolt as a signal that the gun is empty. **ALWAYS** visually check the chamber to insure that the shotgun is empty. See **Figure 30**.



Figure 27

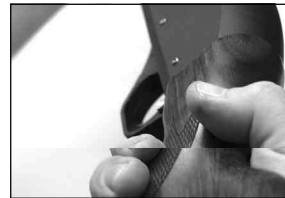

Figure 28



Figure 29



Figure 30

 WARNING

Once you have stopped firing the pump action shotgun, immediately push the cross trigger block safety back to the “on” or “safe” position. Then follow the unloading instructions above while keeping the muzzle pointed in a safe direction.

DIRECTIONS FOR DISASSEMBLY OF THE PUMP ACTION SHOTGUN:

1) Make sure the pump action shotgun is unloaded (**FOLLOW UNLOADING INSTRUCTIONS**) and pointed in a safe direction.



Figure 31

2) Make sure the cross trigger block safety is engaged in the “on” or “safe” position. See **Figure 31**.



Figure 32

3) With the bolt in the forward position, unscrew the magazine tube cap/extension and remove it. **WARNING– THE MAGAZINE CAP IS UNDER PRESSURE!** Grasp the barrel and remove the barrel by pulling the barrel and barrel extension out of the receiver. See **Figure 32**.

4) Grasp the forearm/slide and pull the bolt and action bar forward and out the receiver. See **Figure 33**. Remove the bolt and action bar and forearm/slide assembly from the slide guide tube. Be careful because once the bolt is removed from the receiver all the pieces from the assembly are free to separate. We suggest you keep the gun with the **bolt up** when you remove the assembly so the assembly does not separate. See **Figures 34a, 34b**.



Figure 33

5) The trigger assembly can be removed with the barrel and bolt removed or without the barrel and bolt removed. To remove the trigger assembly all you do is remove the two pins that hold the trigger assembly in place and pull the trigger assembly from the receiver. The pins can be removed with a hammer and a punch. See **Figure 35**.



Figure 34a



Figure 34b



Figure 35

MANUFACTURER’S WARNING:

This firearm was manufactured to properly perform with the original parts as designed. It is your duty to make sure any parts you buy are correctly installed and that neither replacements nor originals are altered or changed. Your gun is a complex tool with many parts that must relate correctly to other parts for safe

and accurate operation. Putting a gun together wrong or with modified parts can result in a damaged gun, or personal injury or death to you or others. Always let a qualified gunsmith work on your gun or at least, check any work not performed by a gunsmith. Firearm safety is your primary concern. **THE GUN OWNER MUST ACCEPT FULL RESPONSIBILITY FOR THE CORRECT REASSEMBLY AND FUNCTIONING OF THE FIREARM AFTER ANY DISASSEMBLY OR REPLACEMENT OF PARTS.**

TO CLEAN AND MAINTAIN YOUR PUMP ACTION SHOTGUN:

- A) Follow procedures for unloading pump action shotgun as described previously.
- B) Follow procedures for disassembly of pump action shotgun as described previously.
- C) Materials needed to clean this pump action shotgun are: a cleaning rod, cotton bore patches, brass bore brush, powder solvent, a small soft brush and good quality gun oil.

WARNING: Lead or lead compounds are known to the State of California to cause cancer, birth defects, reproductive toxicity, and other serious physical injury. Those who clean firearms should take protective measures to avoid contact or exposure to such chemicals.

- D) Using the bore brush with powder solvent, scrub the interior of the barrel and chamber to remove any powder and lead residue in the bore. Always and lastly, swab the interior of the barrel with cotton patch with gun oil to coat and protect the bore and chambers from rust and corrosion.
- E) Any powder fouling on the firing wall, barrel, etc. can be easily cleaned with a brush and powder solvent.
- F) All external surfaces should be wiped down with a light coat of rust preventative. Avoid using too much oil as powder, dust or other foreign material may get trapped in the oil. This could lead to congealed deposits which may interfere with the safe and reliable operation of the pump action shotgun.
- G) **USE CAUTION** while using solvents in gun bore cleaning. Prolonged or excess contact with solvents can damage the gun's bluing and finish. Be sure to wipe away all excess solvent and then lubricate with oil.
- H) A gun should be cleaned after firing. In addition, external parts should be wiped with an oiled cloth after handling. A light oil is ordinarily all that is necessary in cleaning if the gun has not been fired or fired very little. If a gun

is used frequently, it must be cleaned after each firing and regularly serviced by a professional gunsmith. If the gun has been stored, remove all excess oil and/or grease before firing. Always check to be sure that no cleaning patch or other obstruction remains in the bore or chambers before firing.

DANGER – AMMUNITION WARNING

Firearms may be damaged and serious personal injury or death to the shooter or bystanders may result from any condition which contributes to the generation of excessive pressure or uncontrolled release of gas within the firearm. Such adverse conditions can be caused by bore or chamber obstruction, propellant powder overloads or by defective, incorrect or improperly loaded and assembled cartridge components. Even the strongest firearm can be blown up as a result of excessive pressure. It is extremely dangerous to use a cartridge whose pressure is greater than that developed by cartridges loaded to industry standards.

AMMUNITION (CARTRIDGES) NOTICE

We specifically disclaim responsibility for any damage, personal injury or death occurring in connection with or as the result of the use of European American Armory Corp. pump action shotguns with faulty, nonstandard, remanufactured, hand-loaded or reloaded ammunition, used cartridges or cartridges other than factory cartridges for which the firearm was originally chambered.

LUBRICATION WARNING

Firing a pump action shotgun with oil, grease or any other material even partially obstructing the bore may result in damage to the pump action shotgun and personal injury to the shooter and those nearby. Do not spray or apply lubricants directly on ammunition. If the powder charge of a cartridge is affected by the lubricant, it may not fully ignite yet the energy from the primer and/or powder may be sufficient to push the projectile or wad into the bore where it may become lodged. Firing a subsequent cartridge into the obstructed bore will damage the pump action shotgun and may cause personal injury to the shooter and those nearby. Use lubricants properly. You are responsible for the proper care and maintenance of your firearm and ammunition.

ONE YEAR LIMITED WARRANTY

This European American Armory Corp. firearm is warranted to the original retail customer for One Year from date of purchase against defects in material and workmanship. All parts and labor or replacement **at our option** are covered. Wood Stock and Wood Fore end are not covered by the One Year Warranty. The warranty on the wood stock and fore end is 60 days from purchase and only covers manufactured and material defects.

Transportation to and from our repair facilities, government fees, damage caused by failure to perform normal maintenance, sales outside the United States, damage due to use of high velocity, high pressure, reloaded or other nonstandard ammunition, or any unauthorized repair, modification, misuse, abuse, or alteration of the product

are not covered by this Limited Warranty.

Any implied warranties, including the implied warranties of merchantability and fitness for a particular purpose, are limited to one year from date of original retail purchase. Consequential or incidental damages and/or expenses, or any other expenses are not covered by this warranty.

To obtain warranty performance send your firearm with proof of retail purchase, freight prepaid to:

NOTICE: It is illegal to ship a firearm with ammunition in the firearm or in the same packaging. Firearms and ammunition must be shipped separately. For information about shipping ammunition, call European American Armory Corp. at (321) 639-4842.

WARNING—ALTERATIONS OR MODIFICATIONS

Altering or modifying parts and/or internal safeties is dangerous and will void the warranty. This pump action shotgun was manufactured to perform properly with the original parts as designed. It is your duty to make sure any parts you buy are made for this firearm and are installed correctly and that neither the replacements nor originals are altered or changed. Your gun is a complex precision tool with many parts that must relate correctly to other parts in order for proper and safe operation. Putting a gun together wrong or with incorrect or modified parts can result in a damaged gun, danger, and personal injury or death to you and others through malfunction. Always have a qualified gunsmith work on your gun or at least check any work not performed by a gunsmith.

YOUR OWNER'S MANUAL

Always keep this manual with your firearm. Make sure you understand all the warnings, operation instructions and safety procedures. When you lend, give or sell the firearm, be sure this manual goes with it. You can get a copy of this manual from European American Armory Corp. upon request.

ALL PARTS ORDERS ARE SUBJECT TO A \$10.00 CHARGE FOR SHIPPING AND HANDLING. Please state Model, Caliber, Serial Number, and Finish Color when ordering. For parts, information and service contact: European American Armory Corp., 1426 King Street, Cocoa, FL 32922 Phone: (321) 639-4842.

Fig. 1 –MP133 Exploded View

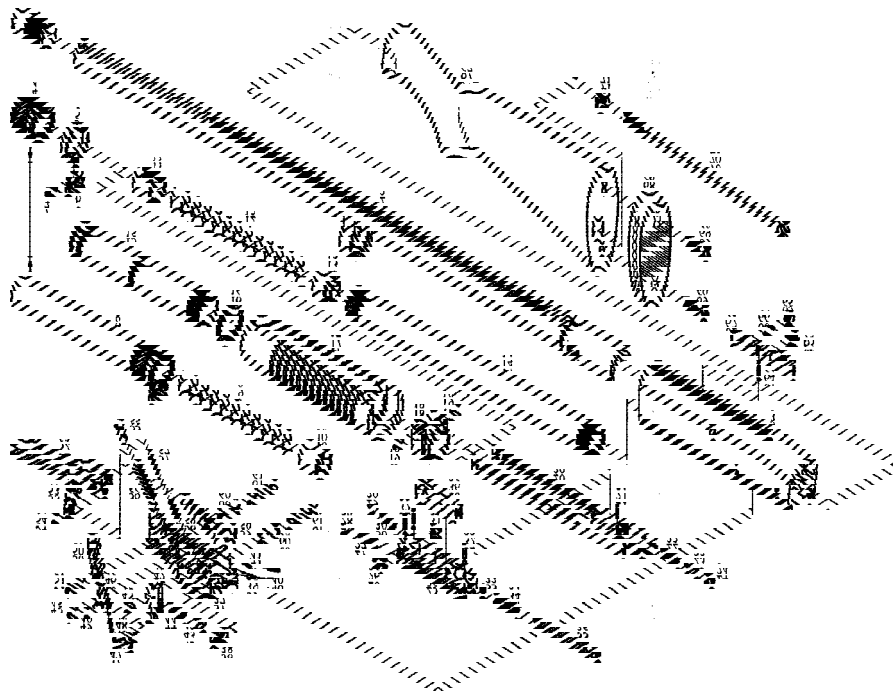

MP133 PARTS LIST

- | | | |
|---------------------------------------|---|--|
| 1. Choke tube | 26. Left extractor | 51. Hammer pivot |
| 2. Barrel | 27. Left extractor spring | 52. Carrier |
| 3. Receiver | 28. Left extractor plunger | 53. Carrier dog |
| 4. Magazine cap | 29. Right extractor plunger | 54. Carrier dog pivot |
| 5. Sling swivel band | 30. Right extractor spring | 55. Hammer plunger |
| 6. Sling swivel ring | 31. Right extractor | 56. Main spring |
| 7. Sling swivel screw | 32. Firing pin retaining pin | 57. Carrier dog plunger |
| 8. Magazine tube extension | 33. Firing pin retractor
spring washer | 58. Carrier spring |
| 9. Magazine tube
extension spring | 34. Firing pin retractor spring | 59. Disconnecter |
| 10. Magazine tube
extension insert | 35. Firing pin | 60. Pin tube |
| 11. Magazine spring retainer | 36. Locking block | 61. Trigger base
retaining pin |
| 12. Magazine spring | 37. Trigger base | 62. Cartridge interceptor |
| 13. Magazine follower | 38. Safety | 63. Cartridge interceptor
spring |
| 14. Magazine tube | 39. Safety plunger | 64. Cartridge interceptor
pivot |
| 15. Forend tube | 40. Safety spring | 65. Cartridge interceptor
button |
| 16. Forend washer | 41. Pin | 66. Cartridge interceptor
button spring |
| 17. Forend | 42. Trigger | 67. Buttstock |
| 18. Forend support | 43. Trigger plunger | 68. Buttplate |
| 19. Pin | 44. Trigger spring | 69. Buttplate woodscrew |
| 20. Action bar assembly | 45. Pivot | 70. Buttstock screw |
| 21. Pin | 46. Sear | 71. Buttstock washer |
| 22. Spring | 47. Trigger bar | |
| 23. Plunger | 48. Sear spring | |
| 24. Bushing | 49. Trigger bar pivot | |
| 25. Bolt | 50. Hammer | |

 **WARNING**

Children are attracted to and can operate firearms that can cause severe injuries or death.

Prevent child access by always keeping guns locked away and unloaded when not in use. If you keep a loaded firearm where a child obtains and improperly uses it, you may be fined or sent to prison.

 **ADVERTENCIA**

A los niños les atraen las armas de fuego y los pueden hacer funcionar. Ellos pueden causarse lesiones graves y la muerte.

Evite que los niños tengan acceso a las armas de fuego guardándolas siempre con llave y descargadas cuando no las esté utilizando. Si usted tiene un arma de fuego cargada en un lugar en que un niño tiene acceso a ella y la usa indebidamente, le pueden dar una multa o enviarlo a la cárcel.

Importer:

European American Armory Corp.
1426 King Street
Cocoa, FL 32922
Phone: (321) 639-4842

Manufacturer:

Izhevsky Mekhanichesky Zavod
8, Promyshlennaya str.,
426063 Izhevsk, Russia